

UNIVERSITY OF ILLINOIS  
AT URBANA-CHAMPAIGN

# HALL PROBE MEASUREMENT OF MAGNETIC FIELDS

*Spring 2019*  
*Eugene V. Colla*



[illinois.edu](http://illinois.edu)

# Hall Probe Measurement of Magnetic Field.

## The main goals of the Lab:

- ✓ Study of the magnetic field distribution created by various systems using Hall probe and Gauss meter.
- ✓ Calculating for simple systems the magnetic field profile and comparing it with experimental data.
- ✓ Getting understanding of the application of the Hall effect to measurements of the magnetic fields.

**This is one week Lab**



# Outline

- ✓ **Magnetic field due to current loops**
- ✓ **Helmholtz coils**
- ✓ **Solenoid**
- ✓ **Halbach magnets**
- ✓ **Hall effect. Measuring of the magnetic field**



# Biot-Savart Law.



Jean-Baptiste Biot  
(1774-1862)



Félix Savart  
(1791-1841)

$$d\vec{B} = \frac{\mu_0}{4\pi} \frac{I d\vec{l} \times \vec{r}}{r^3}$$

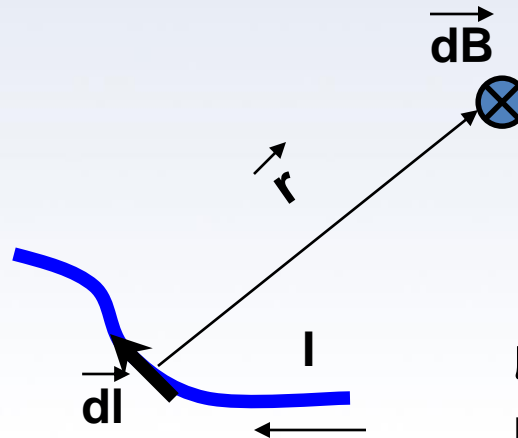

$\mu_0 = 4\pi 10^{-7} \text{ N/A}^2$ ,  
permeability of the  
free space



# Magnetic field due to current loops.

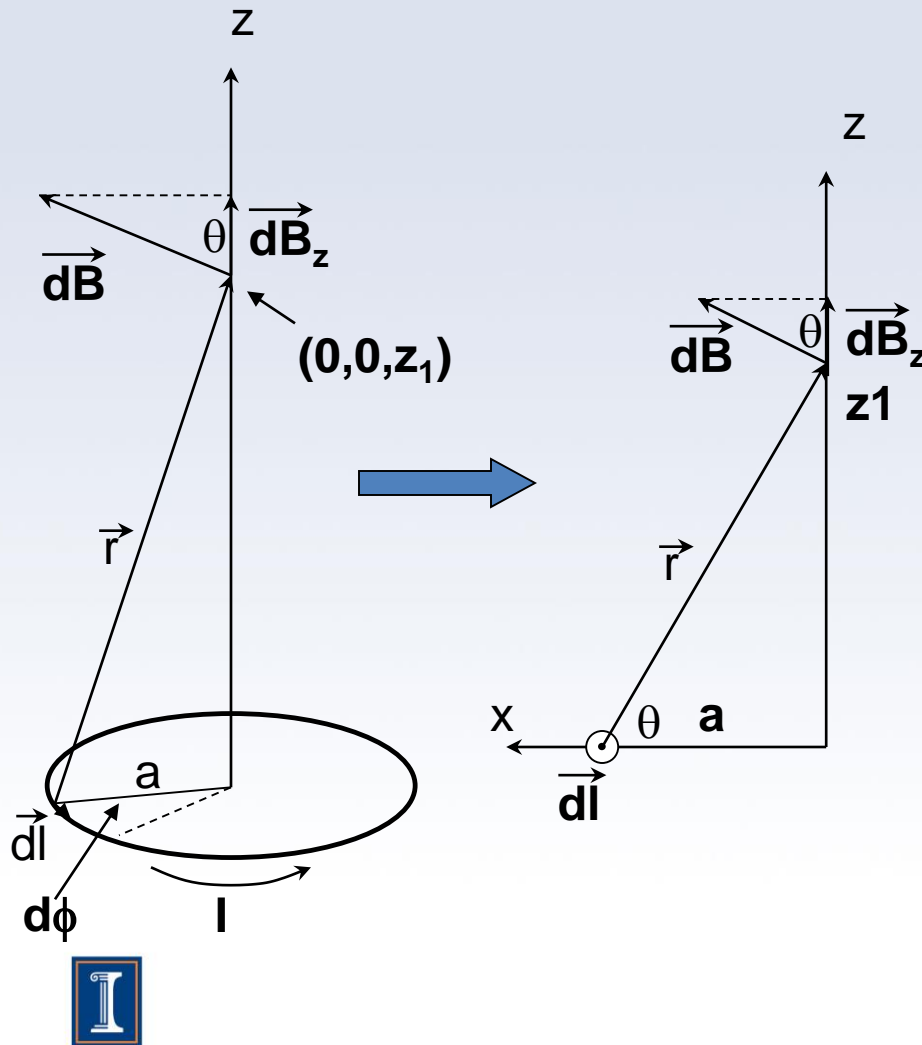

$$|d\vec{l}| = a \cdot d\phi$$

$$dB_z = dB \cos \theta = dB \frac{a}{|\vec{r}|}$$

$$dB_z = \frac{\mu_0}{4\pi} \frac{a^2 d\phi}{|\vec{r}|^3}$$

$$B_z = \oint dB_z = \frac{\mu_0 I}{4\pi} \frac{a^2}{|\vec{r}|^3} \oint dj =$$

$$\frac{\mu_0 I}{2} \frac{a^2}{|\vec{r}|^3} = \frac{\mu_0 I}{2} \frac{a^2}{(z_1^2 + a^2)^{\frac{3}{2}}}$$

# Helmholtz coils.



**Hermann Ludwig  
Ferdinand von  
Helmholtz  
(1821-1894)**

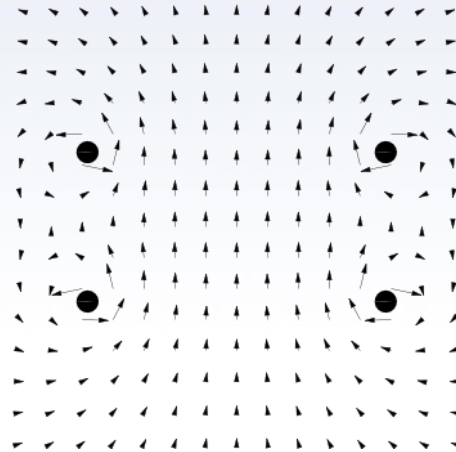

**Magnetic field vector in a plane  
bisecting the current loops.  
(courtesy Wikipedia)**



# Helmholtz coils. Field along the axis.

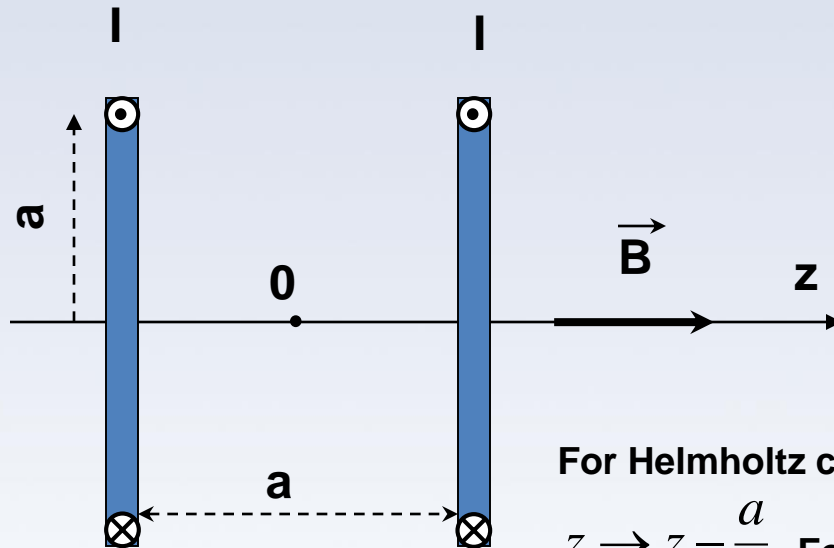

**N turns**

For single loop:

$$\vec{B} = \left\{ \frac{\mu_0 I}{2} \frac{a^2}{(z_1^2 + a^2)^{\frac{3}{2}}} \right\} \hat{z}$$

For Helmholtz coils total current equals  $NI$ ,

$$z \rightarrow z - \frac{a}{2} \quad \text{For right hand coil and}$$

$$z \rightarrow z + \frac{a}{2} \quad \text{for left hand coil}$$



# Helmholtz coils. Field along the axis.

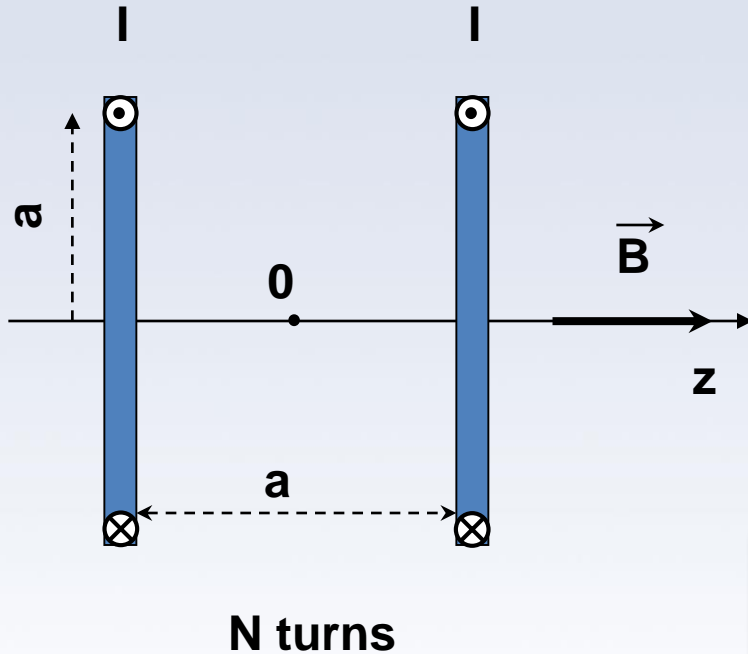

Finally:

$$\vec{\mathbf{B}} = \frac{\mu_0 N I a^2}{2} \left\{ \frac{1}{\left[ \left( z + \frac{a}{2} \right)^2 + a^2 \right]^{\frac{3}{2}}} + \frac{1}{\left[ \left( z - \frac{a}{2} \right)^2 + a^2 \right]^{\frac{3}{2}}} \right\} \hat{\mathbf{z}}$$

or

$$\vec{\mathbf{B}} = \frac{\mu_0 N I}{2a} \left\{ \frac{1}{\left[ \left( \frac{z}{a} + \frac{1}{2} \right)^2 + 1 \right]^{\frac{3}{2}}} + \frac{1}{\left[ \left( \frac{z}{a} - \frac{1}{2} \right)^2 + 1 \right]^{\frac{3}{2}}} \right\} \hat{\mathbf{z}}$$





# Helmholtz coils. Distance between the coils.

## 1. $a=2R$

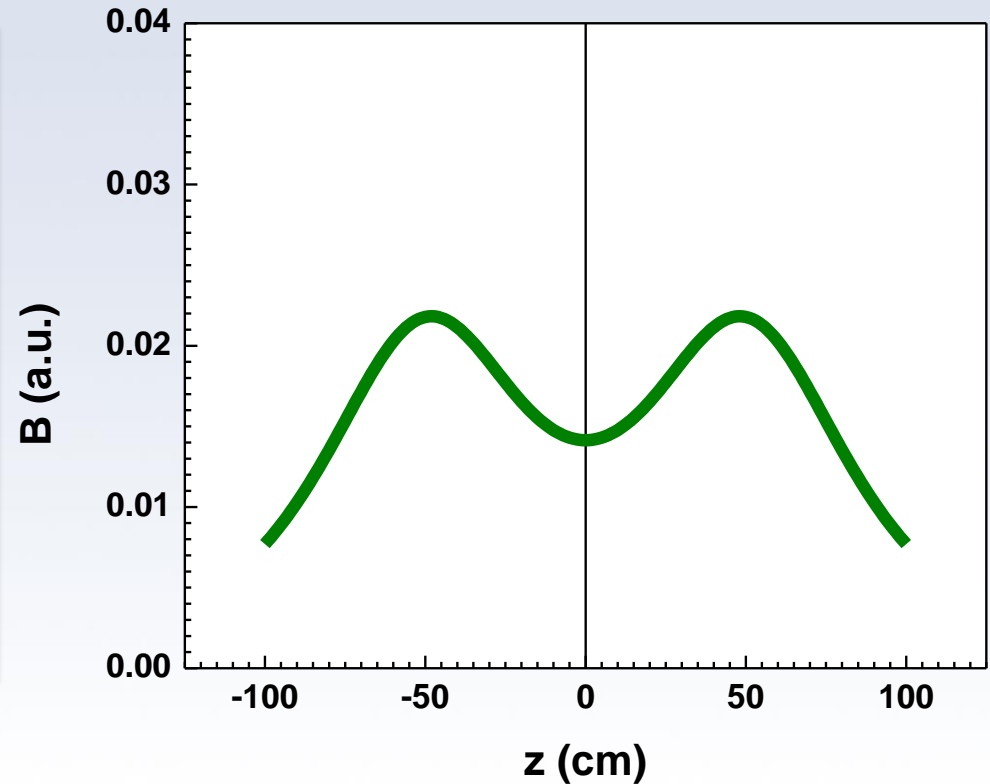
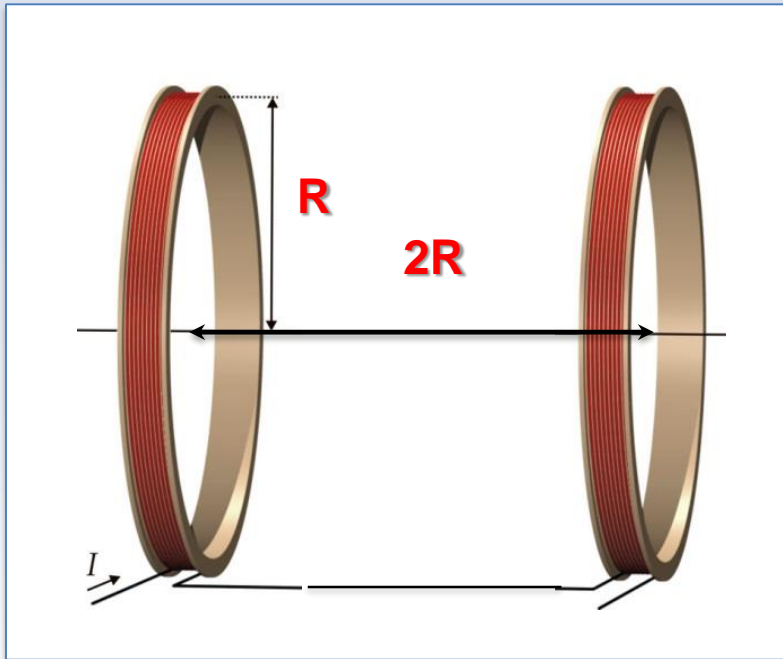

# Helmholtz coils. Distance between the coils.

## 1. $a=1.5R$

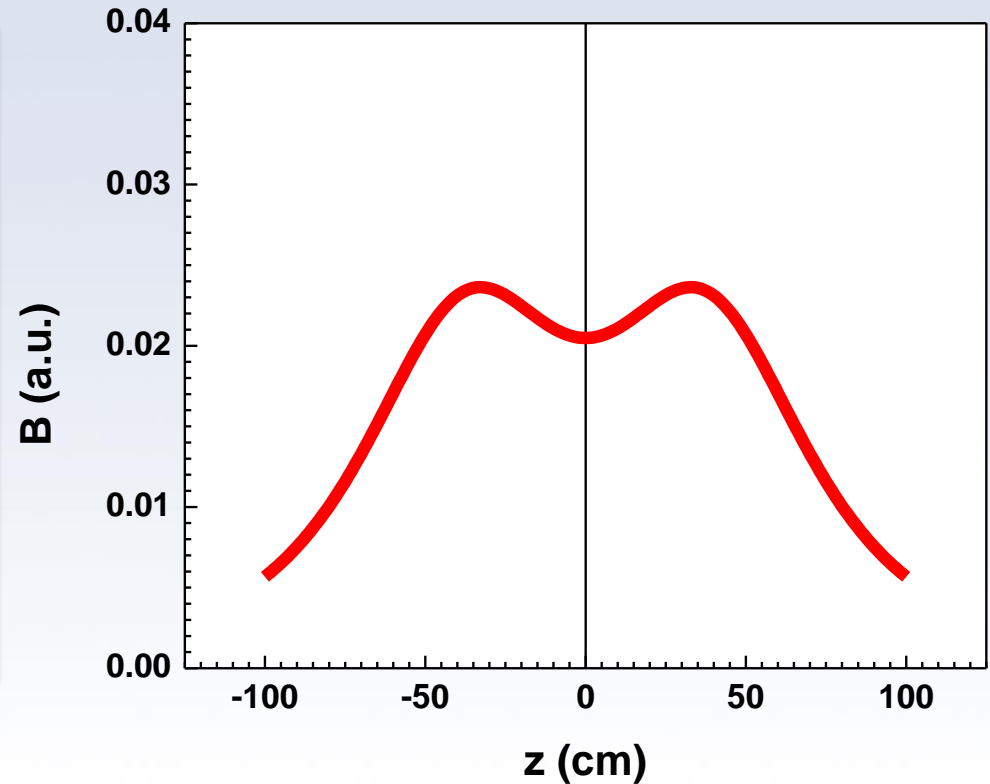
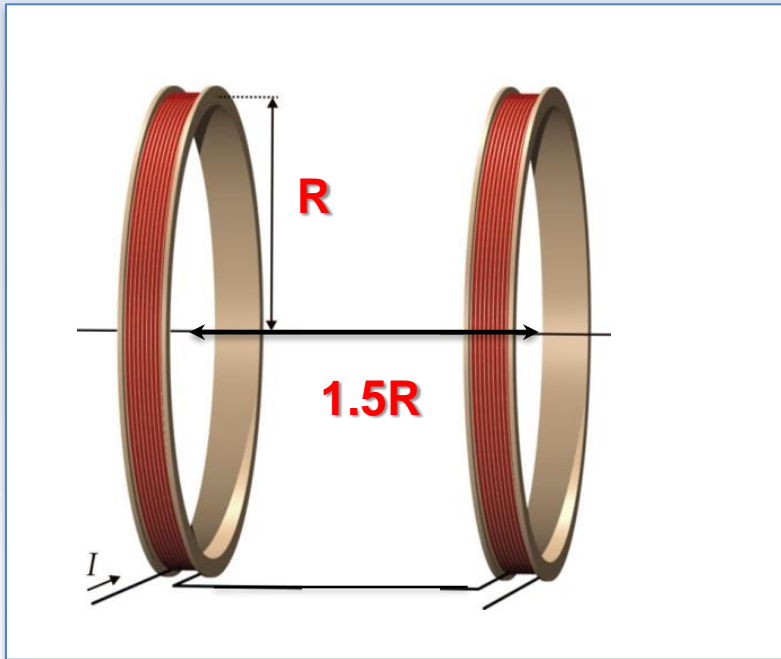

# Helmholtz coils. Distance between the coils.

3.  $a=R$

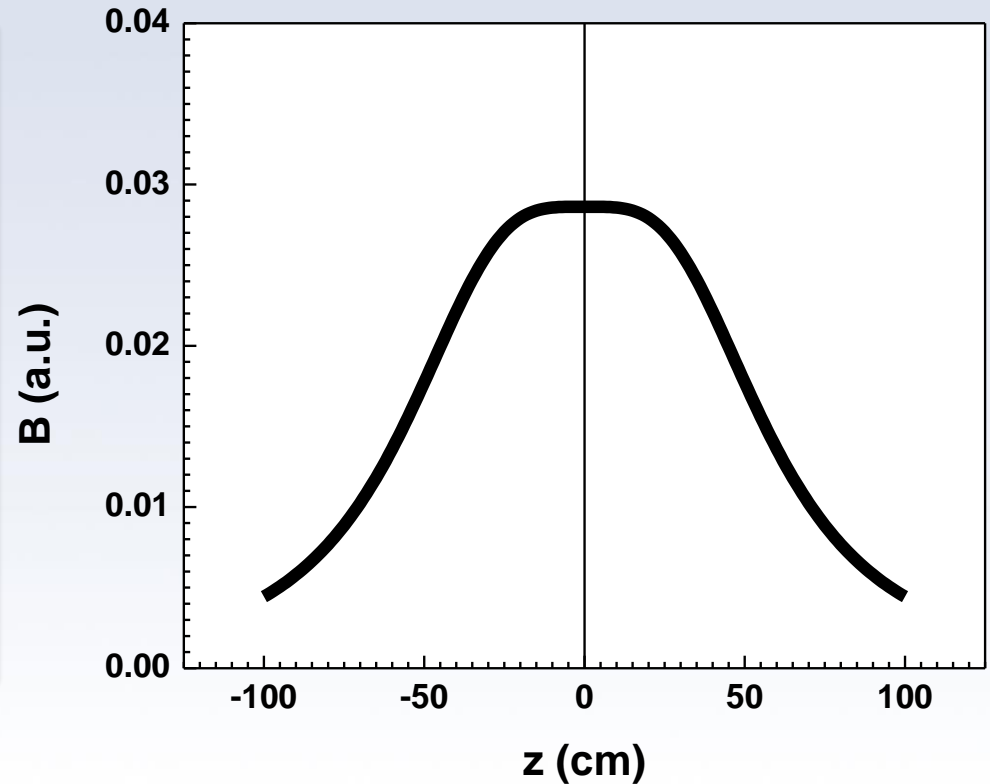
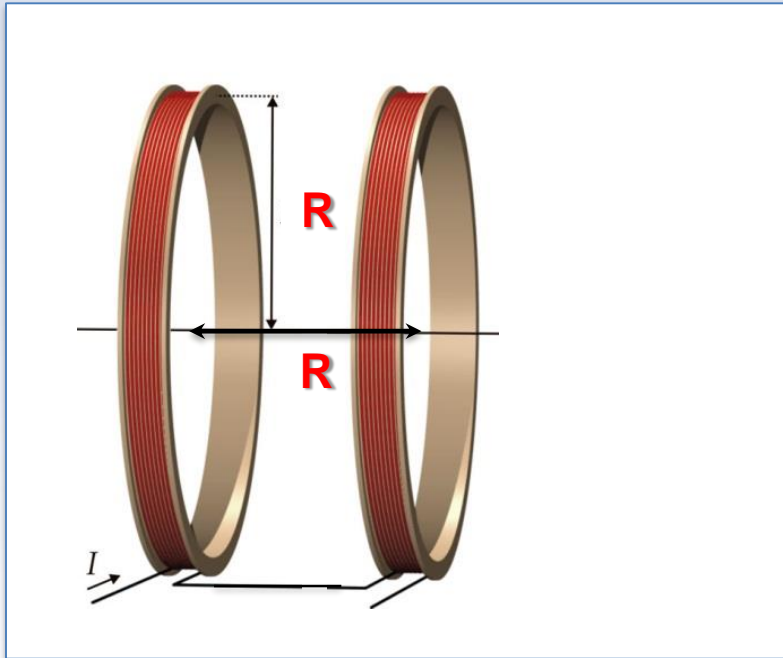

# Helmholtz coils. Distance between the coils.

## 4. $a=0.5R$

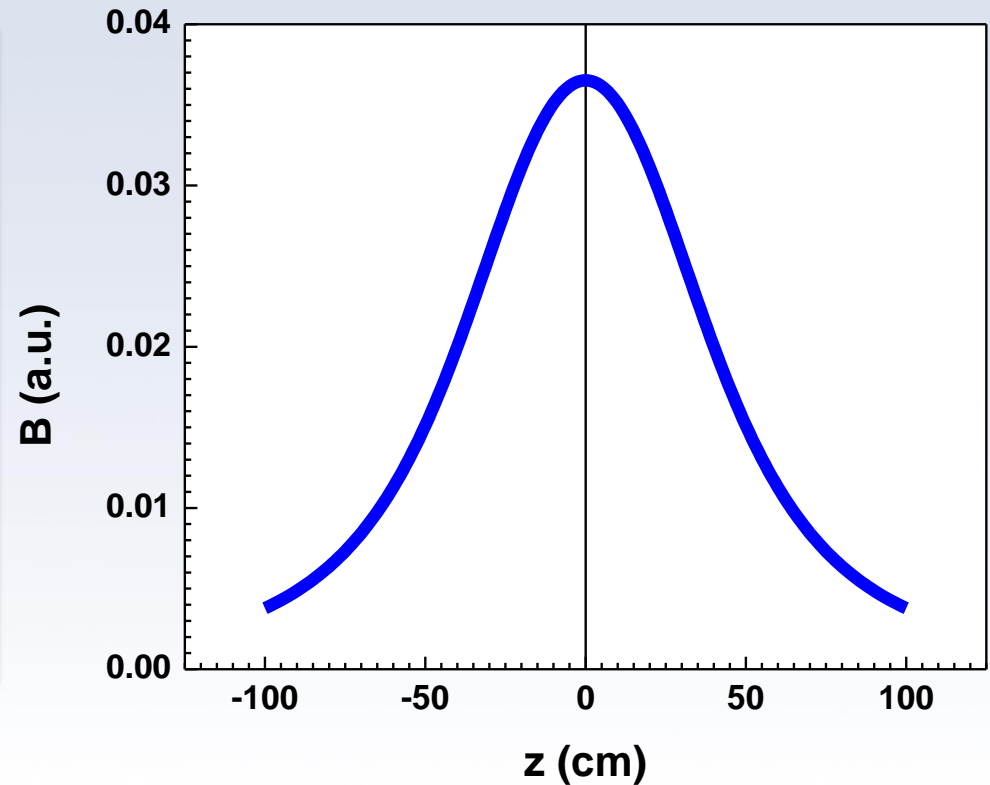
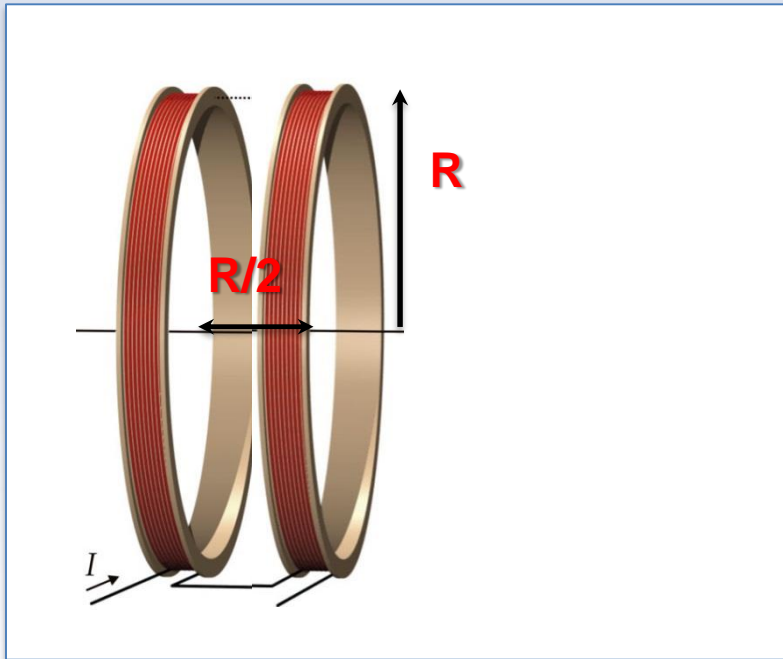

# Helmholtz coils. Distance between the coils.

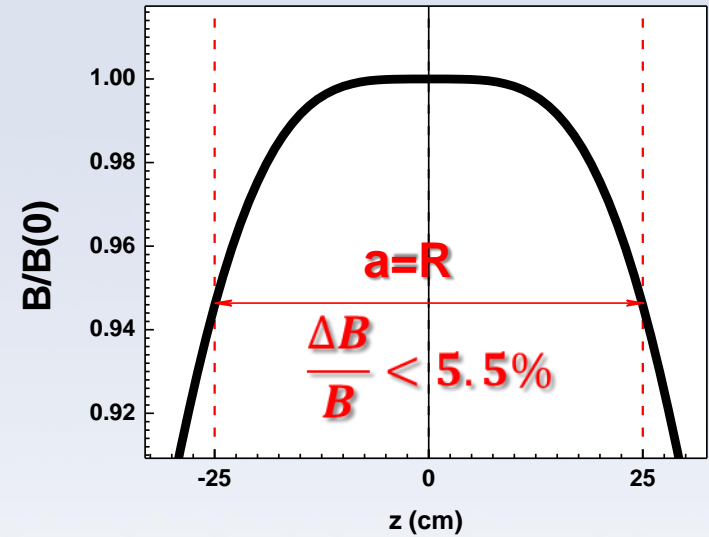
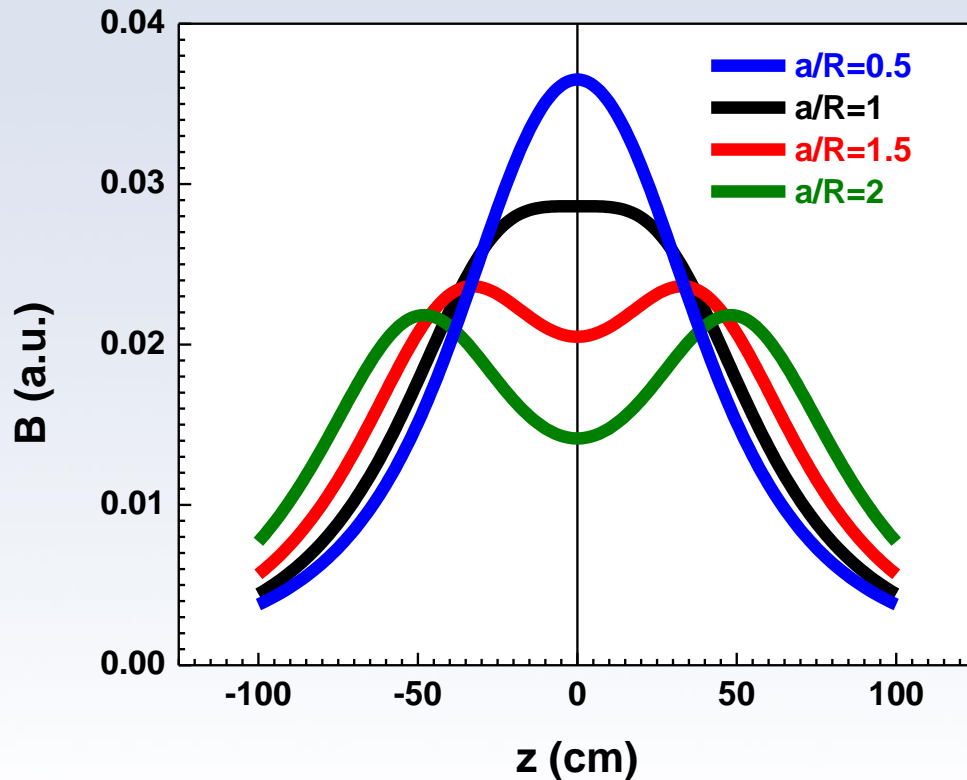

**In the  $z$  range  $-a/4 \div a/4$  the field uniformity is better than 0.5%**



# 3D data visualization of the mapping data.

The results of 2D field mapping can be presented in 3D plot

## Step#1. Plugin your data in the worksheet

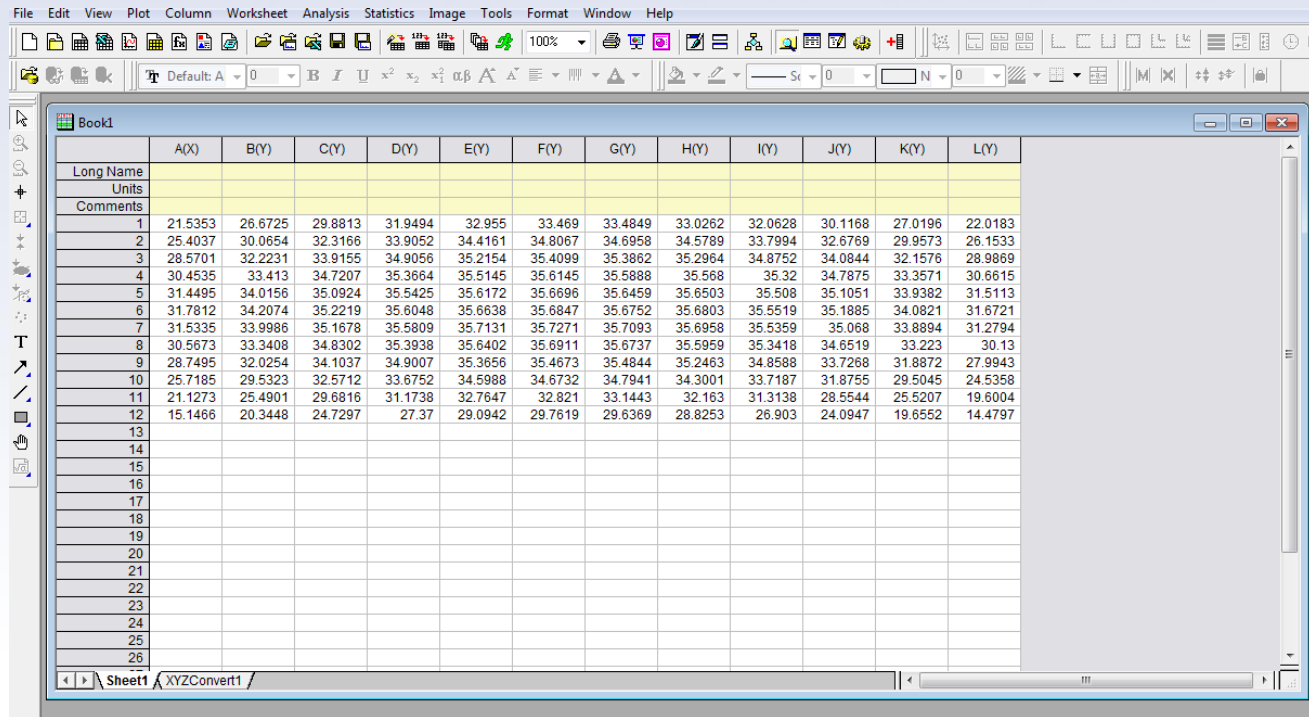

	A(Y)	B(Y)	C(Y)	D(Y)	E(Y)	F(Y)	G(Y)	H(Y)	I(Y)	J(Y)	K(Y)	L(Y)
Long Name												
Units												
Comments												
1	21.5353	26.6725	29.8813	31.9494	32.955	33.469	33.4849	33.0262	32.0628	30.1168	27.0196	22.0183
2	25.4037	30.0654	32.3166	33.9052	34.4161	34.8067	34.6958	34.5789	33.7994	32.6769	29.9573	26.1533
3	28.5701	32.2231	33.9155	34.9056	35.2154	35.4099	35.3862	35.2964	34.8752	34.0844	32.1576	28.9869
4	30.4535	33.413	34.7207	35.3664	35.5145	35.6145	35.5888	35.568	35.32	34.7875	33.3571	30.6615
5	31.4495	34.0156	35.0924	35.5425	35.6172	35.6696	35.6459	35.6503	35.508	35.1051	33.9382	31.5113
6	31.7812	34.2074	35.2219	35.6048	35.6638	35.6847	35.6752	35.6803	35.5519	35.1885	34.0821	31.6721
7	31.5335	33.9986	35.1678	35.5809	35.7131	35.7271	35.7093	35.6958	35.5359	35.068	33.8894	31.2794
8	30.5673	33.3408	34.8302	35.3938	35.6402	35.6911	35.6737	35.5959	35.3418	34.6519	33.223	30.13
9	28.7495	32.0254	34.1037	34.9007	35.3656	35.4673	35.4844	35.2463	34.8588	33.7268	31.8872	27.9943
10	25.7185	29.5323	32.5712	33.6752	34.5988	34.6732	34.7941	34.3001	33.7187	31.8755	29.5045	24.5358
11	21.1273	25.4901	29.6816	31.1738	32.7647	32.821	33.1443	32.163	31.3138	28.5544	25.5207	19.6004
12	15.1466	20.3448	24.7297	27.37	29.0942	29.7619	29.6369	28.8253	26.903	24.0947	19.6552	14.4797
13												
14												
15												
16												
17												
18												
19												
20												
21												
22												
23												
24												
25												
26												



# 3D data visualization of the mapping data.

## Step#2. Convert data to matrix

The screenshot displays the OriginPro 8.5.1 interface. The 'Worksheet' menu is open, and the 'Convert to Matrix' option is selected. A sub-menu is visible with 'Direct' chosen, and an 'Open Dialog...' button is highlighted. In the background, a data table is visible with columns labeled F(Y) through L(Y). In the foreground, a window titled 'MBook5 :1/1' displays a 12x12 matrix of numerical data.

	1	2	3	4	5	6	7	8	9	10	11	12
1	21.5353	26.6725	29.8813	31.9494	32.955	33.469	33.4849	33.0262	32.0628	30.1168	27.0196	22.0183
2	25.4037	30.0654	32.3166	33.9052	34.4161	34.8067	34.6958	34.5789	33.7994	32.6769	29.9573	26.1533
3	28.5701	32.2231	33.9155	34.9056	35.2154	35.4099	35.3862	35.2964	34.8752	34.0844	32.1576	28.9869
4	30.4535	33.413	34.7207	35.3664	35.5145	35.6145	35.5888	35.568	35.32	34.7875	33.3571	30.6615
5	31.4495	34.0156	35.0924	35.5425	35.6172	35.6696	35.6459	35.6503	35.508	35.1051	33.9382	31.5113
6	31.7812	34.2074	35.2219	35.6048	35.6638	35.6847	35.6752	35.6803	35.5519	35.1885	34.0821	31.6721
7	31.5335	33.9986	35.1678	35.5809	35.7131	35.7271	35.7093	35.6958	35.5359	35.068	33.8894	31.2794
8	30.5673	33.3408	34.8302	35.3938	35.6402	35.6911	35.6737	35.5959	35.3418	34.6519	33.223	30.13
9	28.7495	32.0254	34.1037	34.9007	35.3656	35.4673	35.4844	35.2463	34.8588	33.7268	31.8872	27.9943
10	25.7185	29.5323	32.5712	33.6752	34.5988	34.6732	34.7941	34.3001	33.7187	31.8755	29.5045	24.5358
11	21.1273	25.4901	29.6816	31.1738	32.7647	32.821	33.1443	32.163	31.3138	28.5544	25.5207	19.6004
12	15.1466	20.3448	24.7297	27.37	29.0942	29.7619	29.6369	28.8253	26.903	24.0947	19.6552	14.4797



# 3D data visualization of the mapping data.

**Step#3. Plot (here is the color map chosen but you have many options how to plot)**

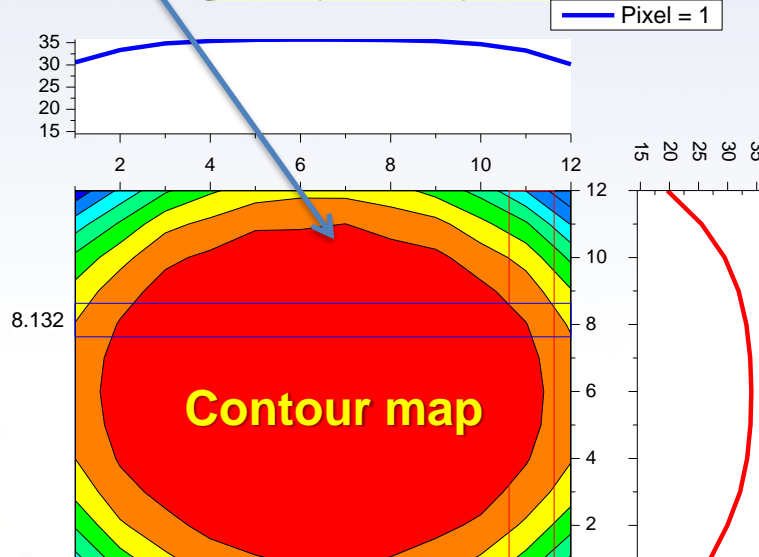
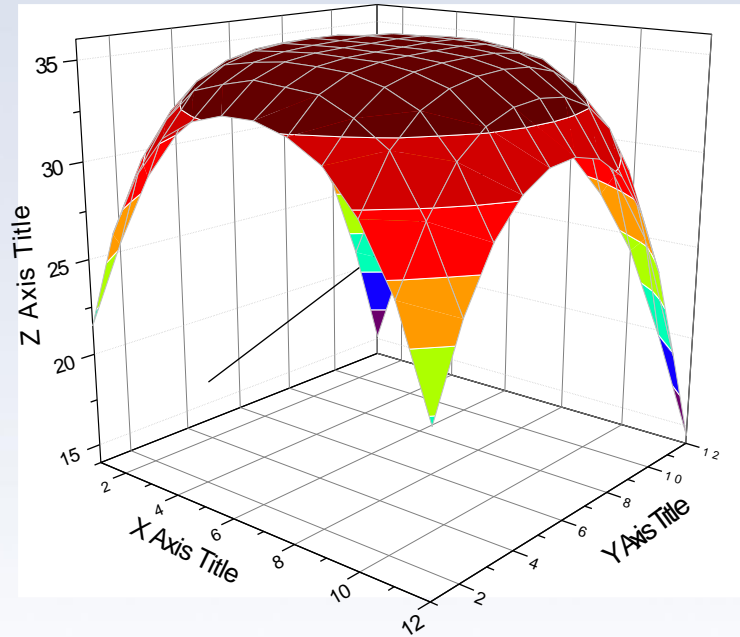
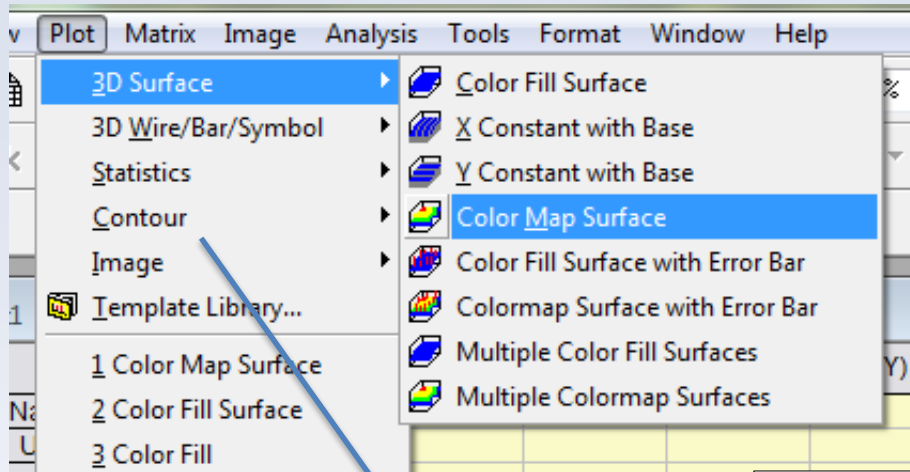

**Color map surface**





# Helmholtz coils. Summary

Helmholtz coils can produce the pretty uniform magnetic field in large volume free of material. Helmholtz coils are not very suitable to generate high magnetic fields.

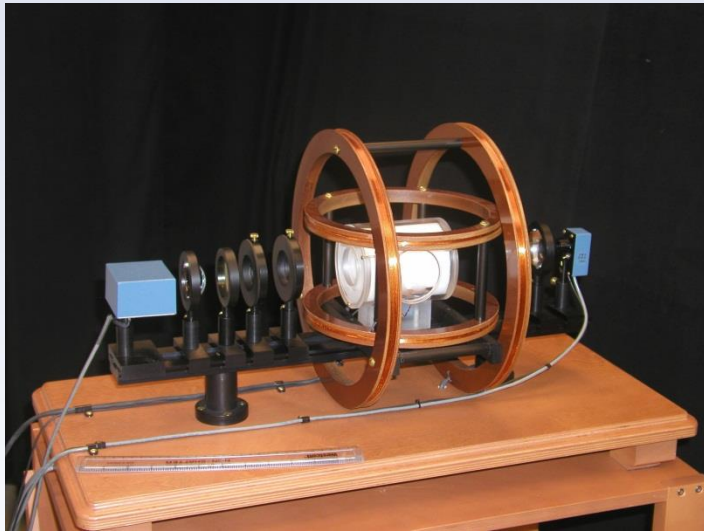

**Helmholtz coils in Rb optical pumping experiment. UIUC Physics 403**

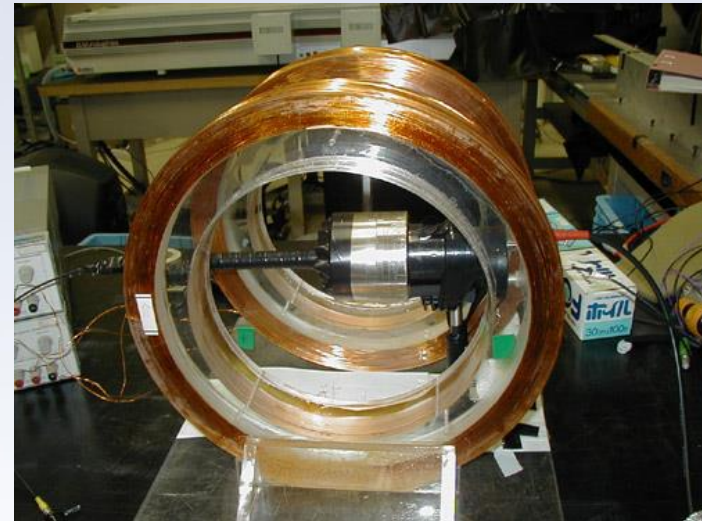

**Helmholtz coil from Brookhaven National Laboratory**



# Solenoids.

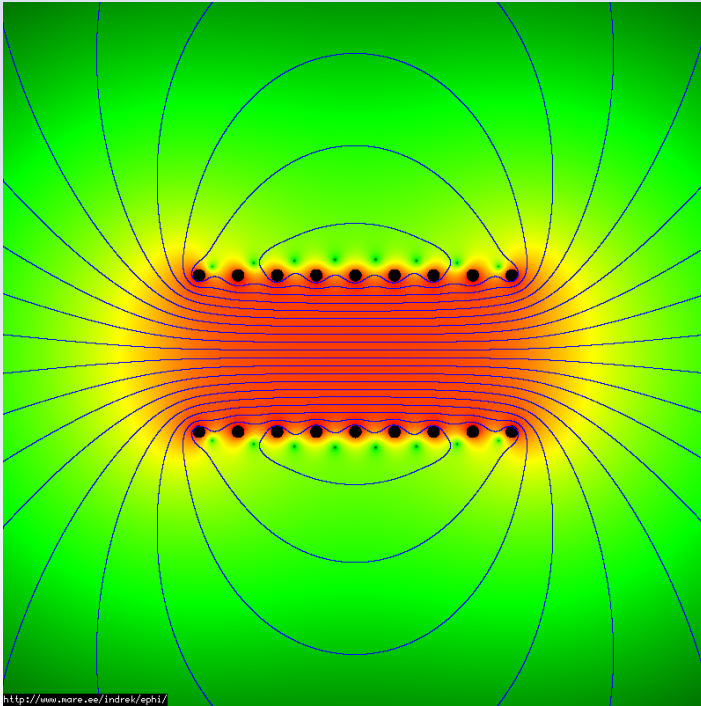

**Solenoids are another source of the uniform magnetic field. Solenoids could be used to produce very high magnetic field.**



# Solenoids. Magnetic field along the axis.

Magnetic field generated by length  $dz$ :

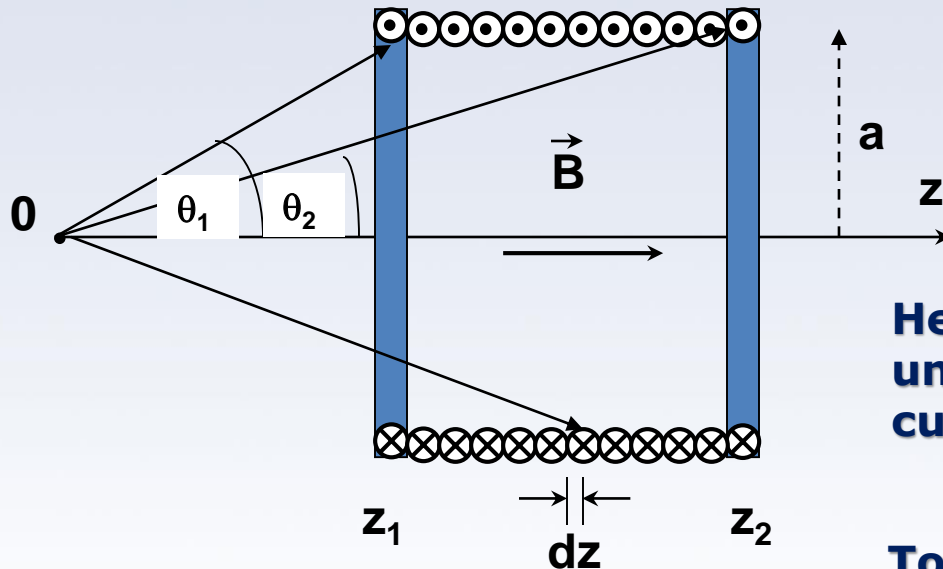

$$\vec{B} = \left\{ \frac{\mu_0 n I dz}{2} \frac{a^2}{(z_1^2 + a^2)^{3/2}} \right\} \hat{z}$$

Here  $n$  is number of turns per unit length and  $I$  – solenoid current

To calculate the magnetic field generated by the whole length of the solenoid we need to perform the integrating from  $z_1$  to  $z_2$



# Solenoids. Magnetic field along the axis.

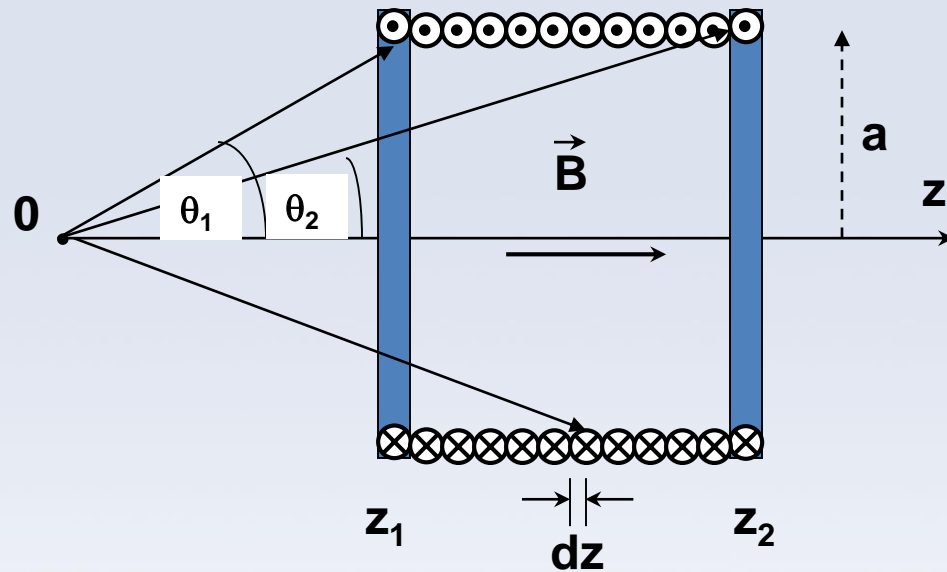

Field from current loop

$$\vec{B} = \left\{ \frac{\mu_0 n I dz}{2} \frac{a^2}{(z_1^2 + a^2)^{\frac{3}{2}}} \right\} \hat{z}$$

$n$  – turns per unit length  
 $I$  – solenoid current

Making the changing variables  $z = \frac{a}{\tan \theta}$

$$\vec{B} = -\frac{\mu_0 n I}{2} \int_{\theta_1}^{\theta_2} \sin \theta d\theta \hat{z} = \frac{\mu_0 n I}{2} [\cos \theta_1 - \cos \theta_2] \hat{z}$$

where  $\cos(\theta_1) = \frac{z_1}{\sqrt{a^2 + z_1^2}}$ ;  $\cos(\theta_2) = \frac{z_2}{\sqrt{a^2 + z_2^2}}$



# Solenoids. How uniform the field is.

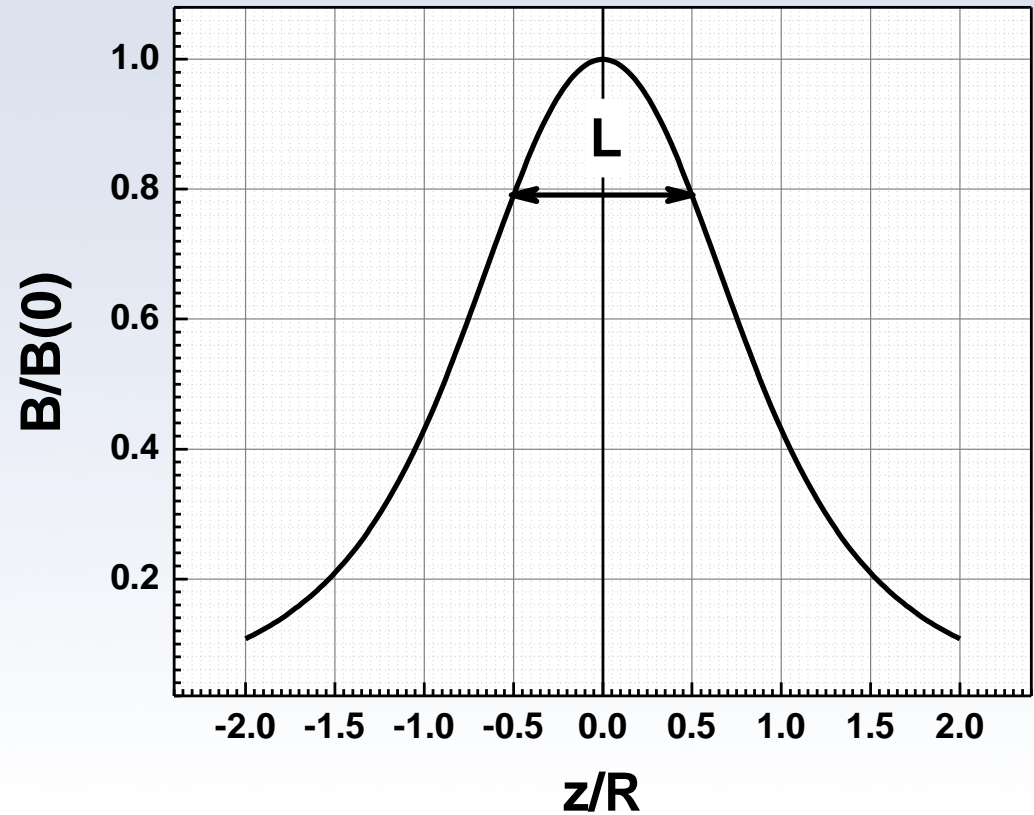
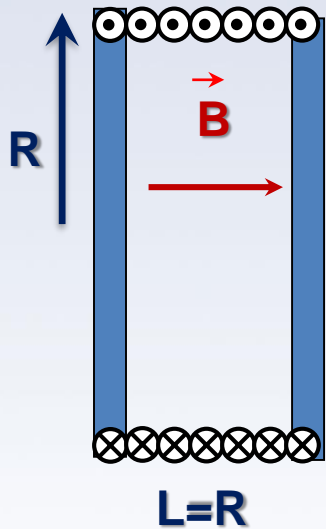

# Solenoids. How uniform the field is.

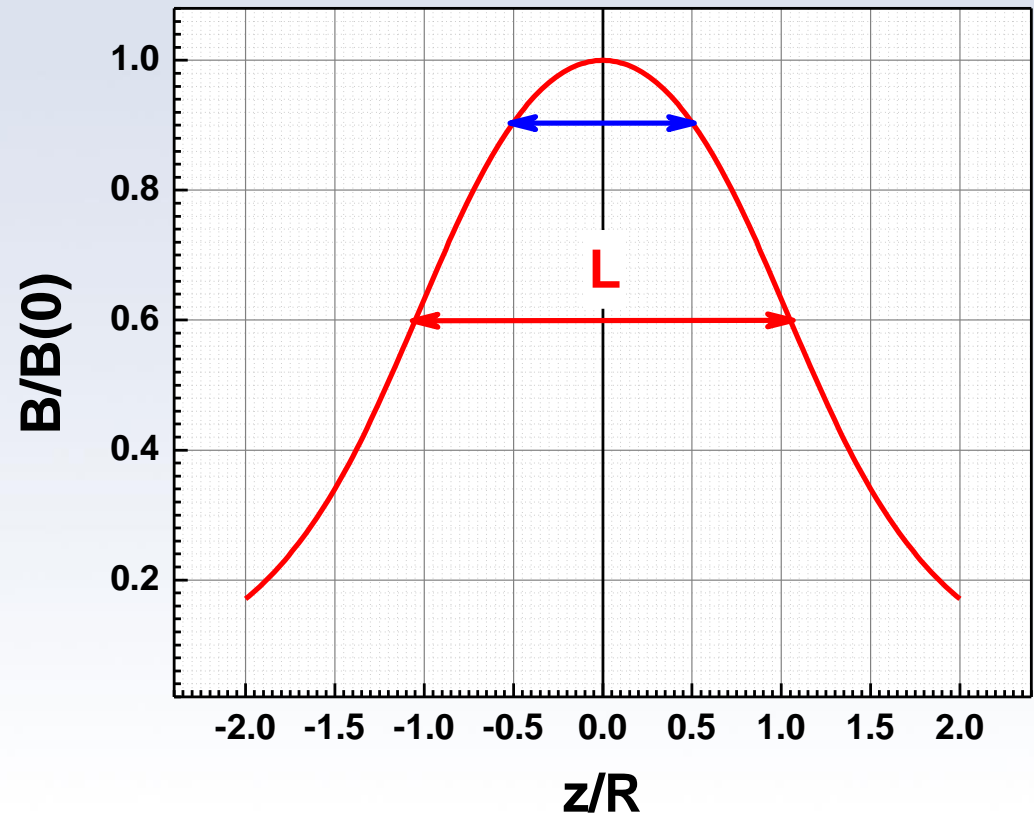
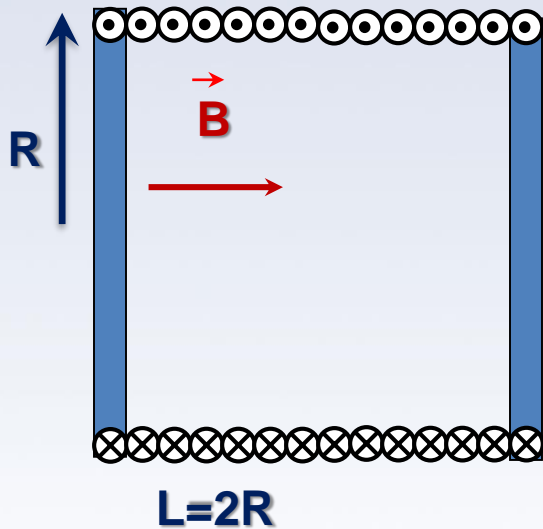

# Solenoids. How uniform the field is.

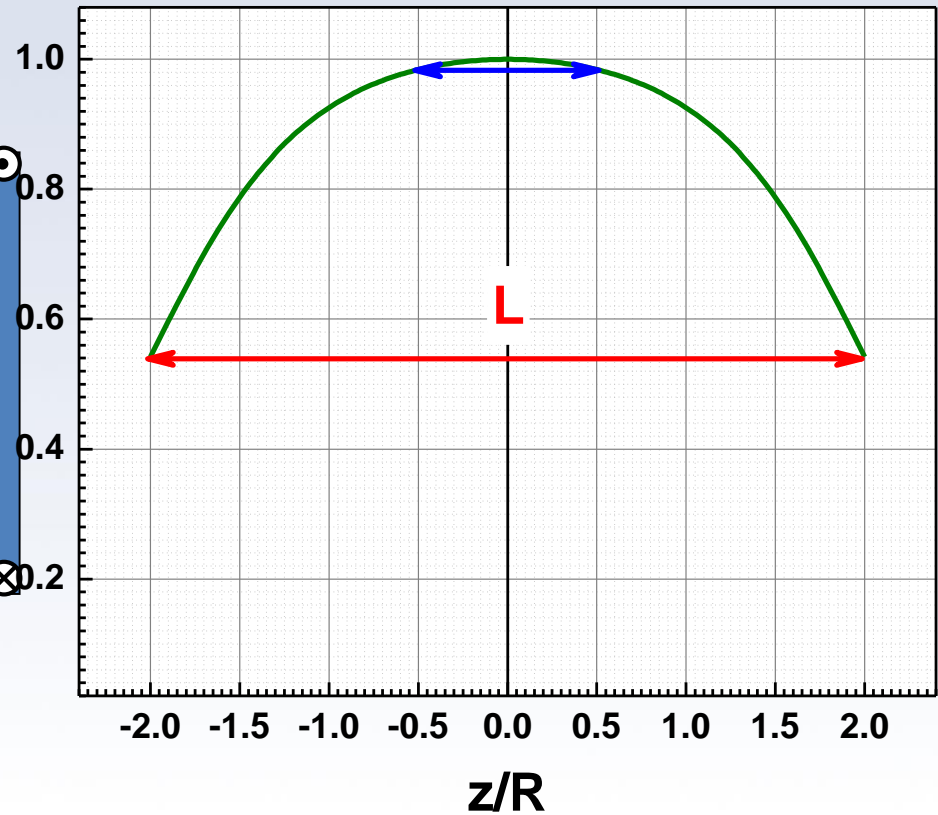

# Solenoids. How uniform the field is.

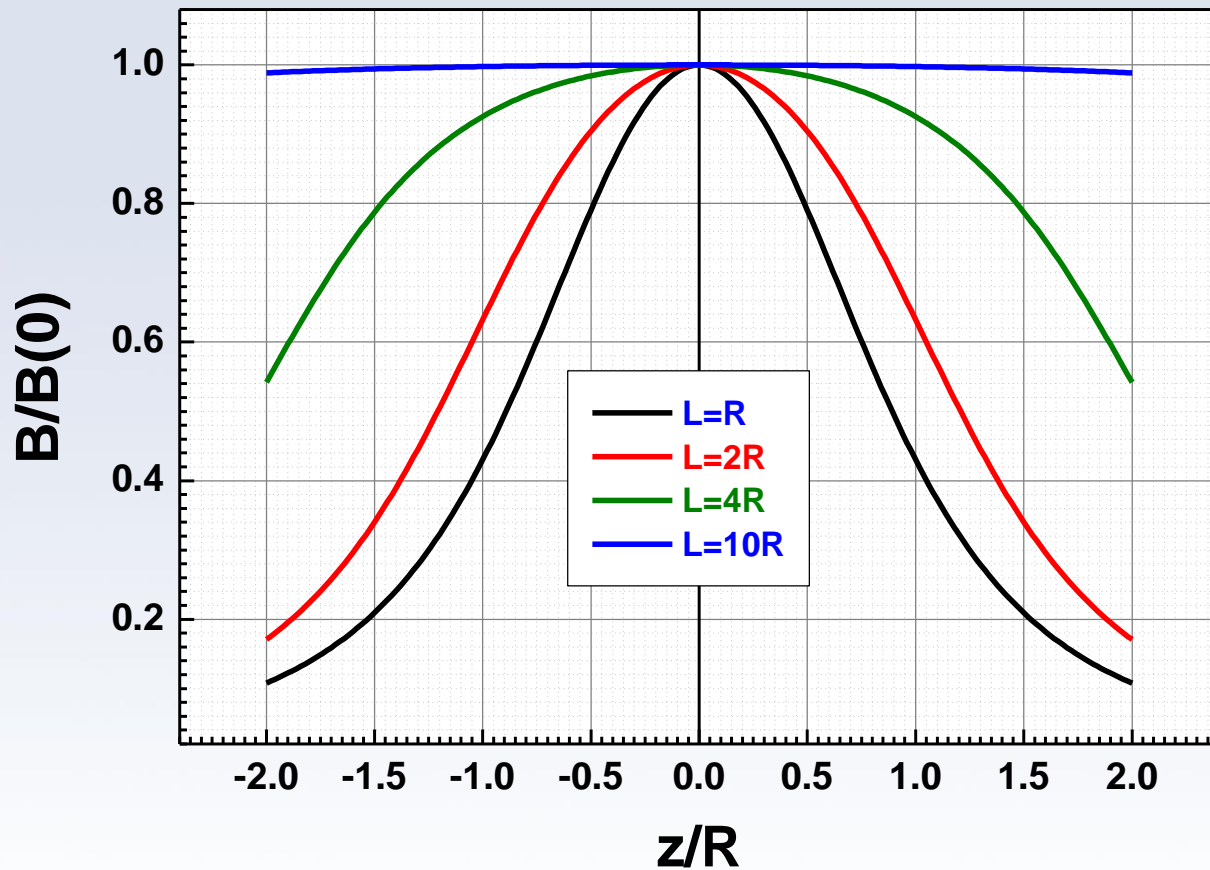

To create the uniform field in solenoid you need you need to wind a long coil with  $L \gg R$





# Solenoids vs. Helmholtz coil.

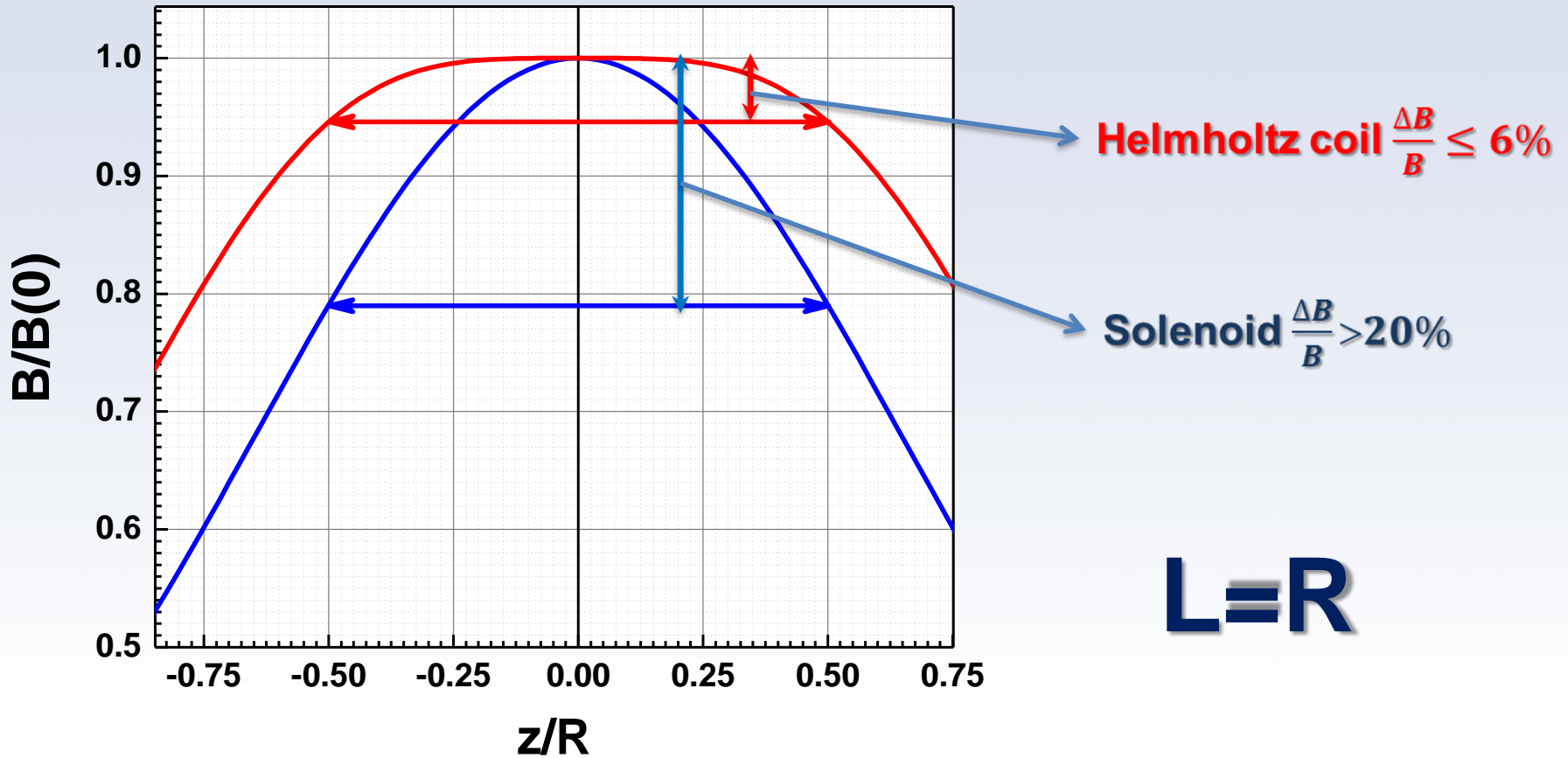

# Solenoids. Calculation of the magnetic field for ideal solenoid using Ampere's law.

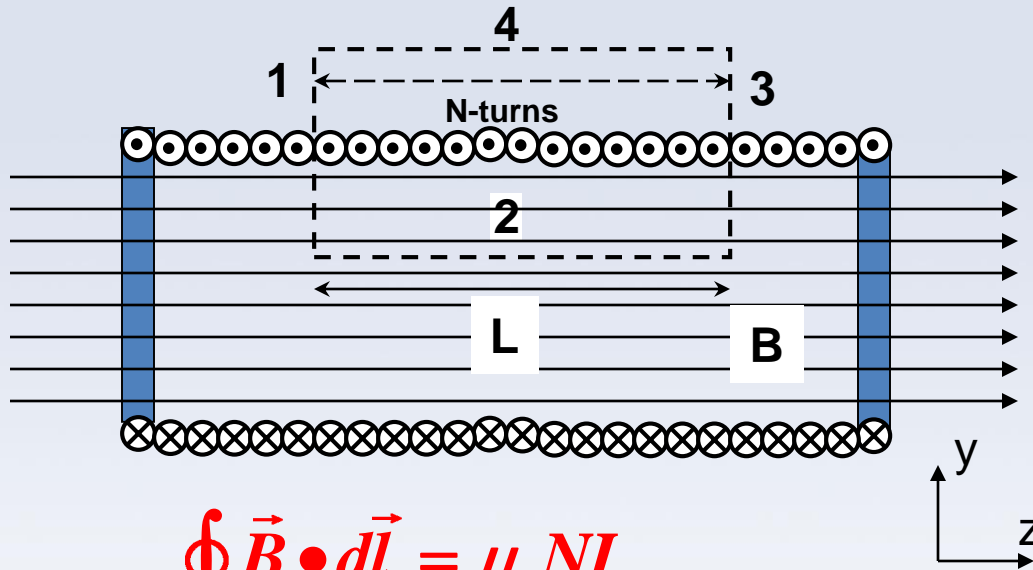

$$\oint \vec{B} \cdot d\vec{l} = \mu_0 NI$$



André-Marie Ampère  
(1775-1836)

$B_z = B$  (inside),  $B_z = 0$  (outside),  $B_y = 0$

$$0 + LB + 0 + 0 = \mu_0 NI$$

and  $B = \frac{\mu_0 NI}{L} = \mu_0 nI$  where  $n = N/L$



# Solenoids. Rates of change of transverse and z-components of $\vec{B}$ .

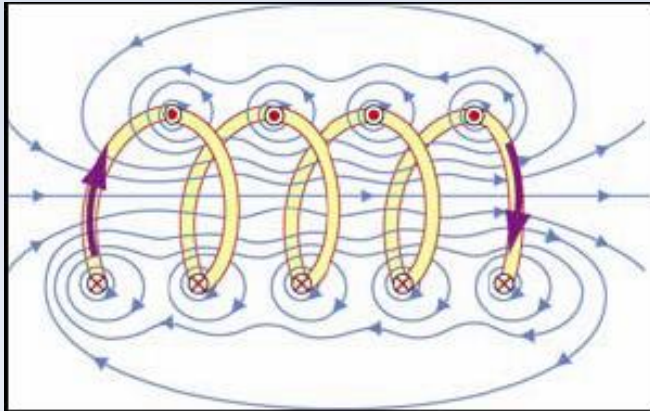

$$\vec{\nabla} \cdot \vec{B} = \frac{\partial B_x}{\partial x} + \frac{\partial B_y}{\partial y} + \frac{\partial B_z}{\partial z} = 0$$

$$\frac{\partial B_x}{\partial x} = \frac{\partial B_y}{\partial y}$$

$$\frac{\partial B_z}{\partial z} = -2 \frac{\partial B_x}{\partial x}$$

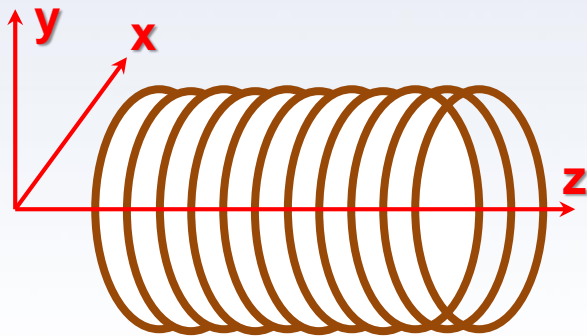

# Superconducting solenoids sources of the very high magnetic fields



17T solenoid (4.2K. 105A)  
from  **CRYOMAGNETICS, INC.**  
INNOVATIVE SUPERCONDUCTING MAGNET SOLUTIONS



22T magnet from



Units: **1T=10<sup>4</sup>G**; typical fields reachable in your experiments **<100G**



# Halbach magnets



**Klaus Halbach**  
**1924-2000**

The late Klaus Halbach of Lawrence Berkeley National Laboratory discovered an interesting permanent magnet configuration that concentrates magnetic flux on one side of the array and cancels it on the other

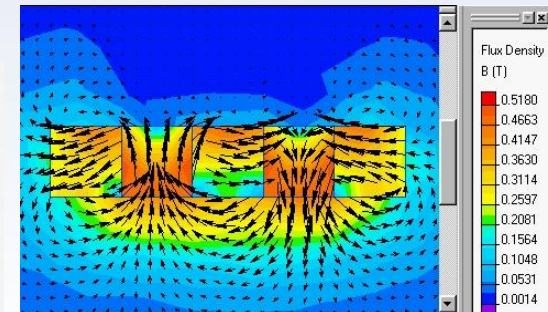
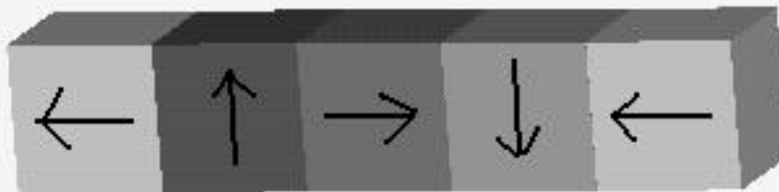

Courtesy MatchRockets.com



# Hall effect



Edwin Herbert Hall  
(1855-1938)

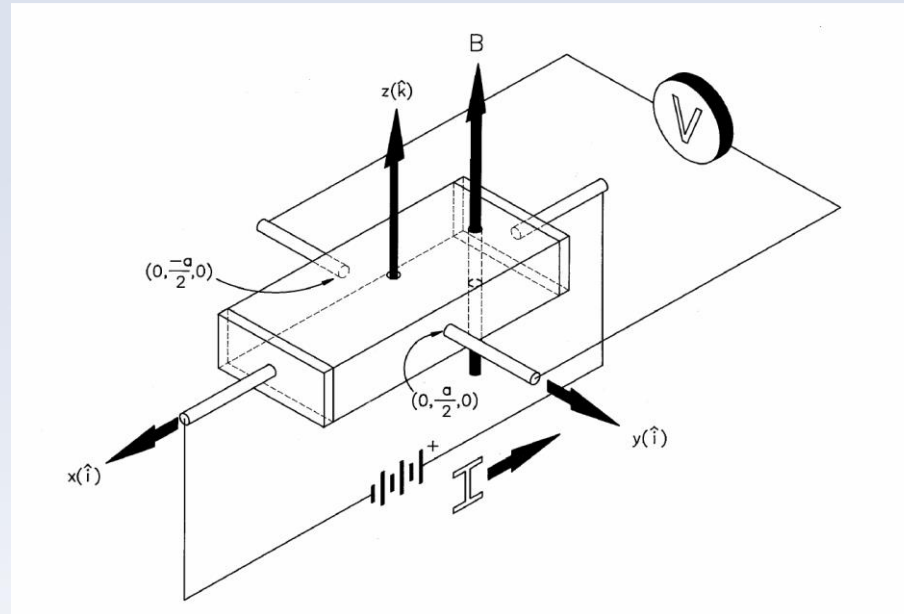

The current in x direction could be written as:  $\vec{I}_x = NqAv_x \hat{x}$

where  $N$  is the concentration of carriers,  $q$  is carrier charge and  $A$  is a cross-section area of the bar and  $v_x$  – drift velocity.



# Hall effect

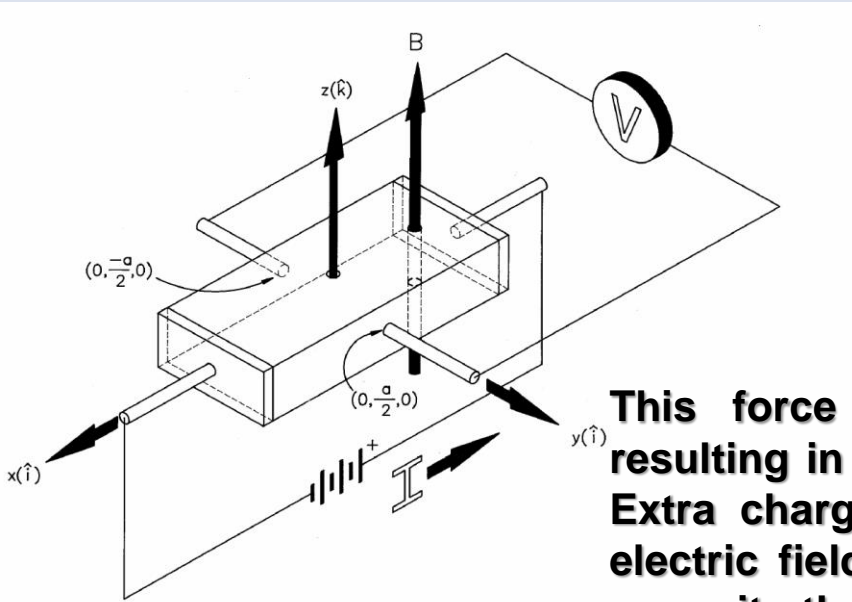

After the field application in z direction the carriers experience a force:

$$\vec{F} = q\vec{v} \times \vec{B} = q \left( \frac{I_x}{NqA} \hat{x} \right) \times B_z \hat{z} = -\frac{I_x B_z}{NA} \hat{y}$$

This force will produce the deflection of the carriers resulting in extra charges on the surfaces normal to y axis. Extra charges will give a rise to an electric field  $E_y$ . The electric field will exerts a force on carriers in the direction opposite the magnetic force. Carriers will flow in y direction until both forces balance:

$$qE_y \hat{y} - \frac{I_x B_z}{NA} \hat{y} = 0 \quad \text{or} \quad E_y = \frac{I_x B_z}{qNA}$$

The equilibrium field could be determined by measuring the potential difference across the sample.

$$V_H = - \int_{-a/2}^{a/2} E_y dy = -E_y a \quad \mathbf{a} - \text{width of the bar}$$



# Hall effect

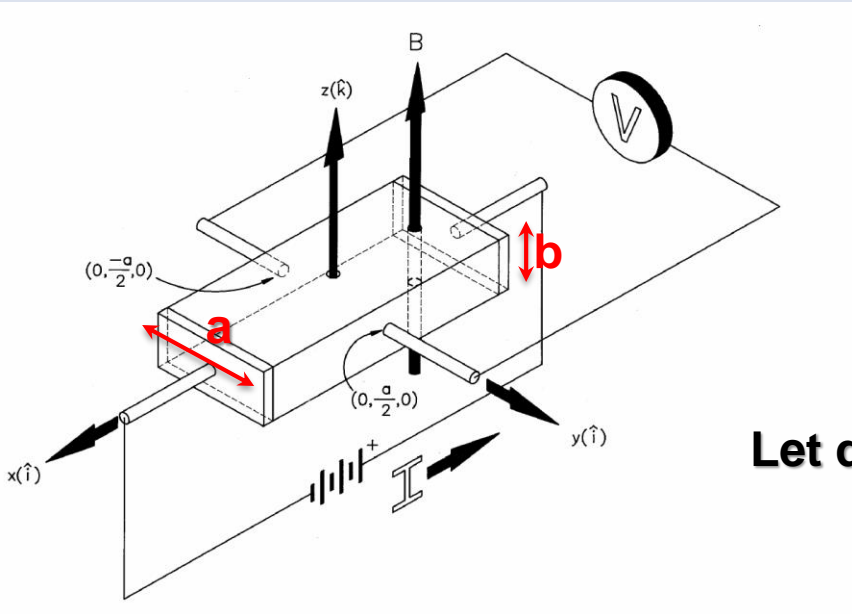

Finally

$$V_H = \frac{I_x B_z}{qNb}$$

(b is a thickness of the bar, A=ab)

Let define

$$R_H = \frac{1}{Nq}$$

as a Hall coefficient

And expression for Hall voltage could be rewritten as

$$V_H = R_H \frac{I_x B_z}{b}$$

Table 1

Material	$R_H$ ( $\text{m}^3/\text{C}$ )
Cu	$-5.3 \times 10^{-11}$
Na	$-21.0 \times 10^{-11}$
Cr	$+35.0 \times 10^{-11}$
Bi	$-10^3 \times 10^{-11}$
InAs (approx.)	$-10^7 \times 10^{-11}$





# Setup

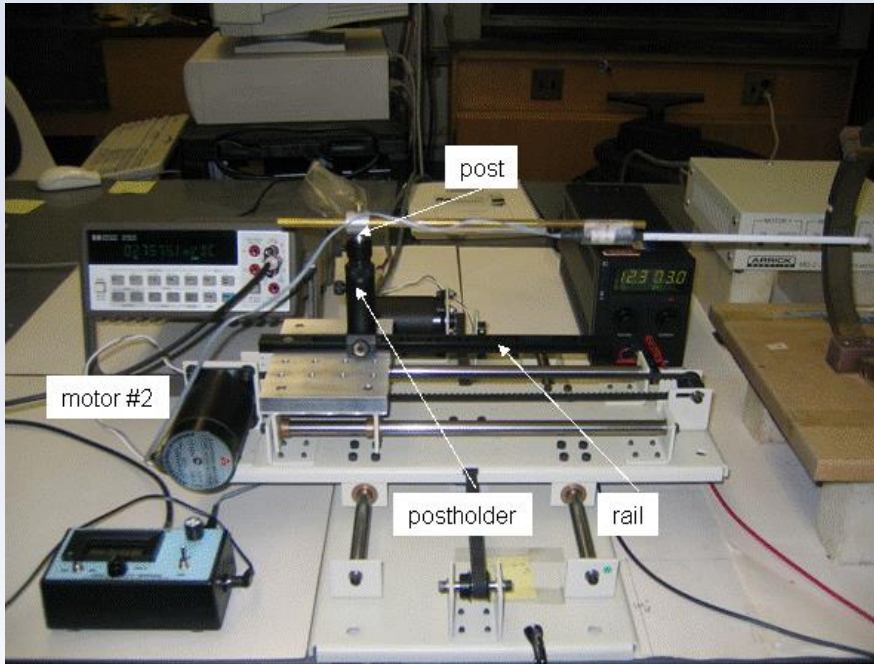

**X-Y scanning equipment**

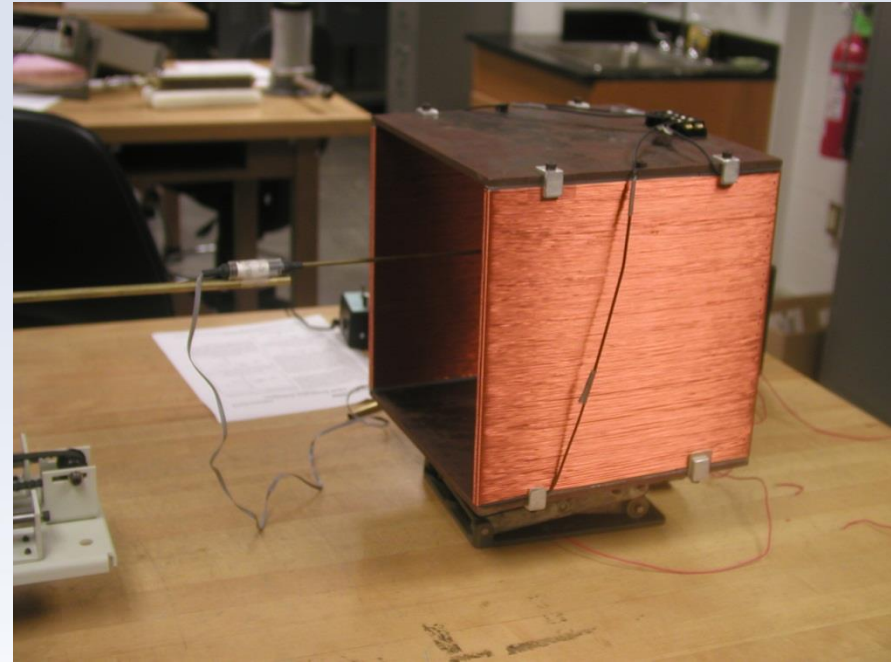

**Hall probe scanning the  
“iron box” magnet**



**Be smart! Do not forget about the symmetry of the investigated magnetic system.**

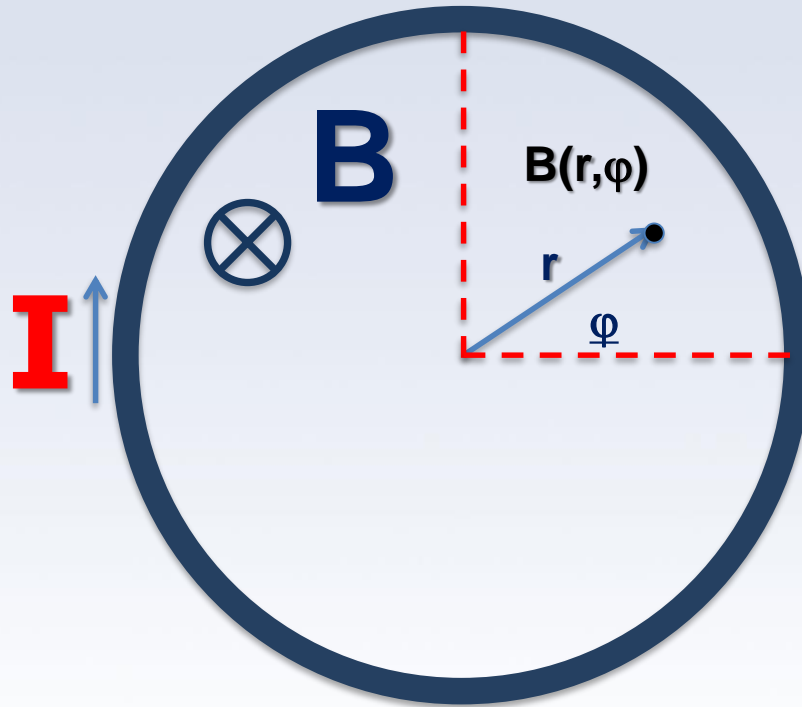

$$\mathbf{B}(r, \varphi) = f(r) \neq f(\varphi)$$

**Magnetic field created with the circular loop (solenoid, Helmholtz coil) depends only on radius  $r$  but not on the angle  $\varphi$**



# Simulation of the Magnetic Field Created by the Permanent Magnets using MatLab

\\engr-file-03\PHYINST\APL Courses\PHYCS401\Common\Halbach Magnets

The screenshot shows the 'Halbach Magnet Simulation' window. It features a central plot area and several control panels. The panels are annotated with blue circles and numbers 1 through 6:

- 1 Scanning Grid Setup:** Includes input fields for Step Size (0.1), No. of Steps (20), Initial Position (-1,1), and m Value (1).
- 2 Magnet Array Setup:** A table with 8 rows and 4 columns (x, y, theta). The first row is highlighted in green.
- 3 Calculation Controls:** Includes 'Calculate!' and 'Clear Cal Data' buttons.
- 4 Plotting Options:** Includes 'Plot Type' (Contour), 'Component' (Bx), 'Data Mask' (0.10), and 'Save As' (fig). Buttons for 'Plot' and 'Save Figure' are also present.
- 5 Data File Management:** Includes 'Type in data file names' section with input fields for Bx, By, X Grid, and Y Grid. Buttons for 'Load Exp Data' and 'Clear Exp Data' are also present.
- 6 Save:** A 'Save...' button.

Courtesy of Longxiang Zhang

Documentation:

*HalbachSim - The most useful README in the world.docx*

